

Pump Model CPS 200-150-605

Speed 1450rpm

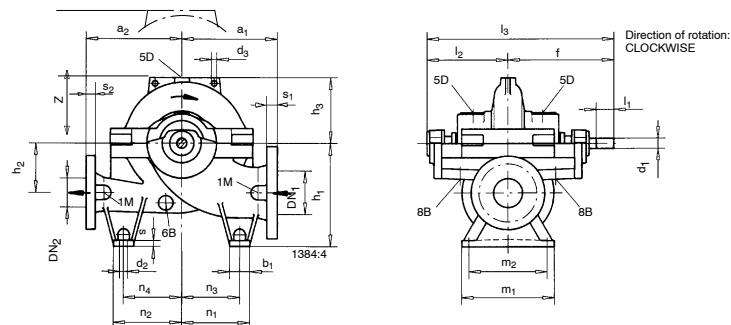
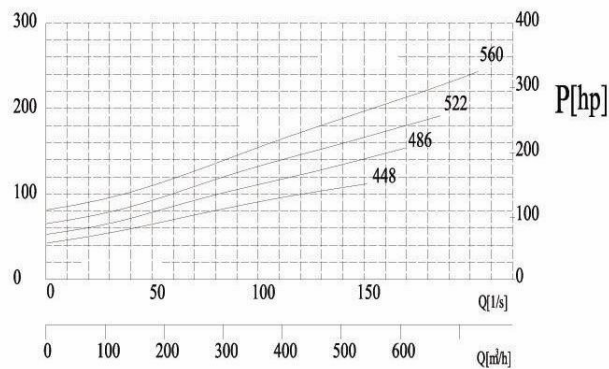
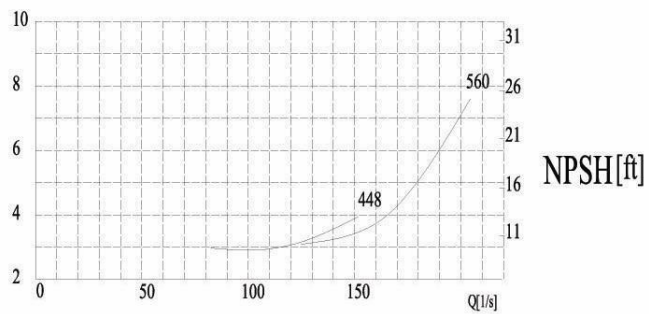
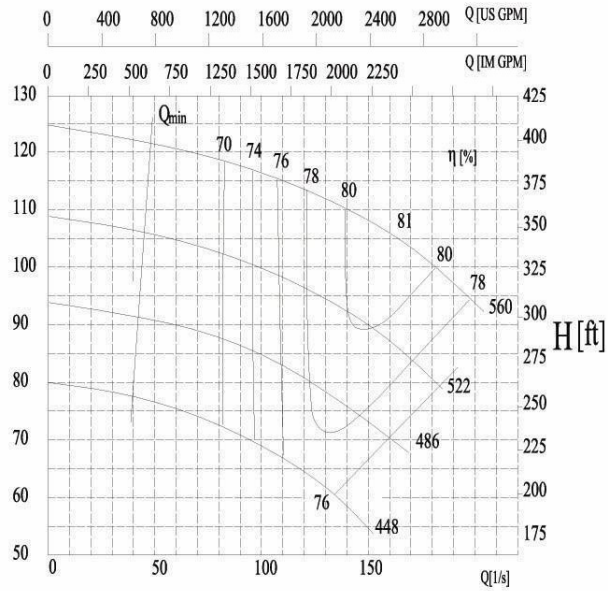

Pump Size	FLANGE DIMENSIONS				PUMP DIMENSIONS									
	DN1	DN2	s1	s2	a1	a2	d3	f	h1	h2	h3	l2	l3	z
CPS 200-150-605	200	150	41	37	600	600	19	590	500	300	370	399	989	740
	FOOT DIMENSIONS									SHAFT		PUMP WEIGHT		
	b1	d2	m1	m2	n1	n2	n3	n4	s	d1	L1	(kg)		
70	18	480	430	385	385	350	350	20	55	125	656			